

YANMAR[®]

DIESEL ENGINES

TNVseries

Max. Output
13.4~96.6hp

YANMAR[®]



YANMAR CO.,LTD.

1-32, Chayamachi, Kita-ku, Osaka 530-8311, Japan
Telephone:+81-6-6376-6411 Facsimile:+81-6-63774243
www.yanmar.co.jp

Note: All data subject to alteration without notice.

Printed in Japan
001A0-G00420 0810

The TNV series adds a whole range of “goodies” that make this engine a mechanical “Work of art”

The much acclaimed “Clean and Silent” TNE series has just become even better. Its called the TNV, and it stands for Total New Value. Lets take a look.....

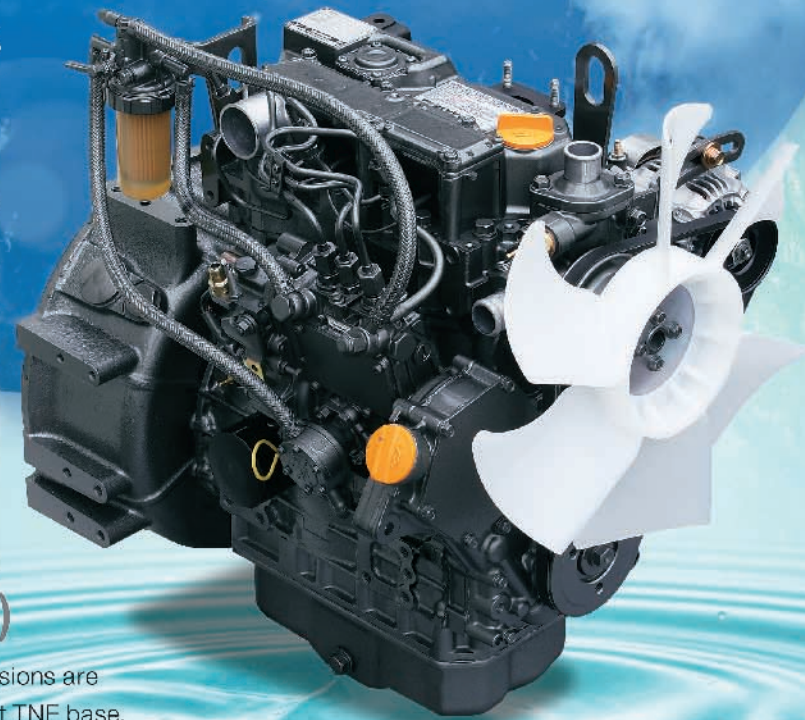

Emission Reduction (ie a Cleaner Engine)

Cleaner engines with even lower exhaust emissions are achieved by improving on the already excellent TNE base. Stricter emission standards are cleared by a wide margin.

IDI engines

1. Combustion Chamber

By investigating flow characteristics using experimental and numerical analysis methods, Yanmar research has achieved improved flow mixing in both the main chamber and the special mouth surrounding the injector. More efficient use of the incoming air charge results in cleaner burn and lower exhaust emissions.

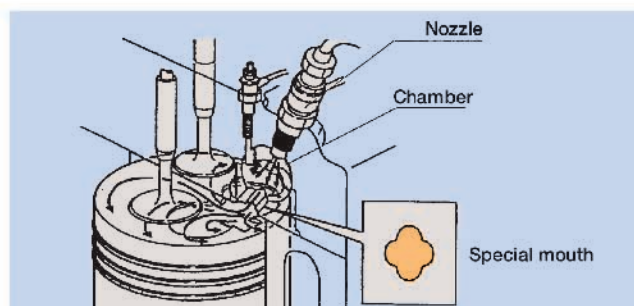

2. Fuel Injection Equipment Mechanical Pump

Instead of a PFR pump, a newly developed in-line pump has been used for the smaller TNV engines. Adjustments are made solely in the Yanmar’s own FIE factory ensuring precise compliance with regulations. Also the following features are incorporated:

- Increased force is applied by the governor to quicken the fuel controlling rack response time. Engine revs are more constant. Matching to a wide range of machinery is simplified.
- Emissions have been reduced by controlling fuel injection timing according to engine load.
- Cam profiles are matched to nozzle throttle needs, which give a better controlled injection rate. Emissions are reduced.

DI engines

1. Nozzle Installation Angle

The installation angle of the fuel injection nozzle is greater than that in conventional engines, so that uneven atomization of fuel between injections can be reduced. Excellent matching between intake swirl ratio and the shape of the combustion chamber has resulted in uniform mixing of fuel in the combustion chamber. Therefore, performance including combustion efficiency, startability, noise, and exhaust emission has been improved.

On the 4TN94L, -98 and -98T by using 2 inlet and 2 exhaust valves, air intake and expulsion is markedly improved. Vertically mounted injector nozzle minimizes imbalance of spray pattern.

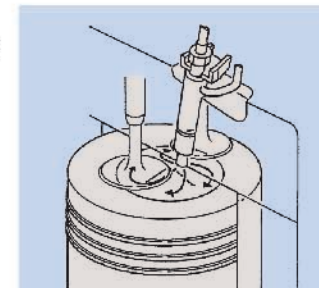

2. Combustion Chamber

It increases the fluid energy of the air and fuel charge. The swirl effect produced in the chamber continues while combustion occurs, aiding mixing and results in lower exhaust emissions compared to conventional chambers.

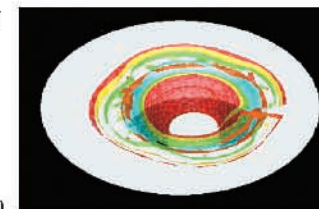

3. Fuel Injection Equipment

● MP Pump

A new MP pump has been developed especially for the TNV engine series. Our aim was to make improvements over a wide range of areas to even further reduce emissions.

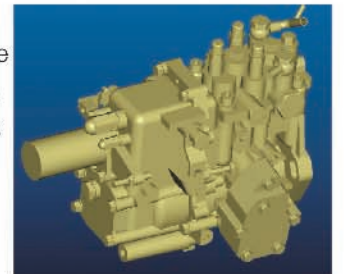

Features are:

- High injection pressure
- Use of a mono plunger reduces uneven injection between the cylinders. Timing Control Device system optimizes injection to take into account speeds, loads and the startup phase.
- New mechanical governor helps to maintain cleaner exhausts.
- Minimal variation from chosen revs at low speed using constant pressure valve.

● Fuel Injection Nozzle

- Multiple numbers of very small holes are used to achieve uniform atomization.
- Holes are not simply drilled, their inside edges are carefully rounded to promote even flow and direction of spray, also to reduce resistance.
- Low sack nozzle profile improves combustion. Double corn shape protects from cavitation.

Noise Level Reduction (ie a more Silent Engine)

1. Cylinder Block Noise Reduction

Yanmar’s original CAE techniques have optimized the stiffness, minimized transformation, and reduced radiant noise.

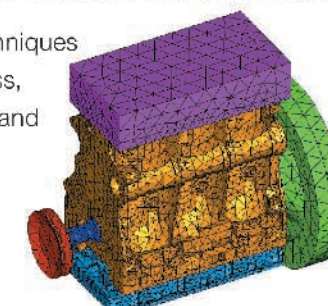

2. Muffler Noise Reduction

Original CAE technique is used to design a muffler with optimized volumes and sound isolation materials.

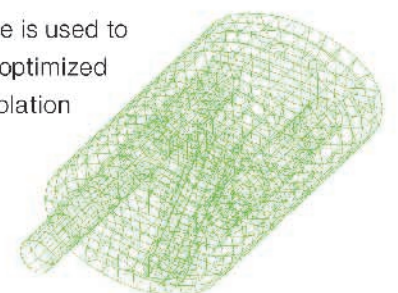



Engine Specifications

Engine Model	2TNV70	3TNV70	3TNV76	3TNV82A (-B)	3TNV84T (-B)	3TNV88 (-B)	4TNV84T (-B)	4TNV88 (-B)	4TNV94L (-B)	4TNV98	4TNV98T	4TNV106	4TNV106T	
Type	Vertical cylinder, 4-cycle water-cooled diesel engine													
Combustion	Indirect injection (DI)					Direct injection (DI)								
Aspiration	Natural Aspiration				Turbocharged	Natural Aspiration		Turbocharged	Natural Aspiration			Turbocharged	Natural Aspiration	Turbocharged
No. of cylinders	2		3			4								
Cyl. Bore x stroke	mm 70 x 74		76 x 82	82 x 84	84 x 90	88 x 90	84 x 90	88 x 90	94 x 110	98 x 110		106 x 125		
Displacement	Litter 0.570		0.854	1.116	1.331	1.496	1.642	1.995	2.190	3.053	3.319		4.412	
Direction of rotation	Counterclockwise (viewed from flywheel)													
Governor system	Mechanical													
Cooling System	Radiator													
Lubrication System	Forced lubrication by trochoid pump													
Starting System	Electric starting													
Dry mass (back plate)	kg 73	87	94	111	150	138	165	155	-	-	-	-	-	
Dry mass (Bell housing)	kg 84	98	112	128	159	148	170	165	235	245	320	340		
Applicable Emission Regulation	EPA IT4 Compliance	-	-	○ (≥ 19kW)	○ (≥ 19kW, -B)	○ (≥ 19kW, -B)	○ (≥ 19kW, -B)	○ (≤ 37kW, -B)	○ (-B)	○ (≤ 37kW)	-	-	-	
	EPA Tier1 Compliance	○	○	○ (≤ 19kW)	○ (≤ 19kW, -B)	○ (≤ 19kW, -B)	○ (≤ 19kW, -B)	-	-	-	-	-		
	EC Stage II A (Generator use)	-	-	○ (≥ 19kW)	-	○ (≥ 19kW, -BG)	-	○	-	○	○	-	-	
	EC Stage III A (Industrial use)	-	-	○ (≥ 19kW)	○ (≥ 19kW)	○ (≥ 19kW)	○	○ (≤ 37kW)	○	○ (≤ 37kW)	-	-	-	
China Stage II Compliance	○	○	○	○	○	○	○	○	○	○	○	○		

Output

Model		2TNV70	3TNV70	3TNV76	3TNV82A (-B)	3TNV84T (-B)	3TNV88 (-B)	4TNV84T (-B)	4TNV88 (-B)	4TNV94L (-B)	4TNV98	4TNV98T	4TNV106	4TNV106T		
Industrial use	NET kW/ NET hp/ Gross kW	3600	9.9/13.3/10.5	15.5/20.8/17.0	20.2/27.1/22.3	-	-	-	-	-	-	-	-	-	-	
		3400	9.6/12.9/10.1	14.7/19.7/16.1	19.3/25.9/21.2	-	-	-	-	-	-	-	-	-	-	
		3200	9.3/12.5/9.8	14.0/18.8/15.1	18.2/24.4/19.9	-	-	-	-	-	-	-	-	-	-	
		3000	9.1/12.2/9.5	13.7/18.4/14.6	17.9/24.0/19.2	21.9/29.4/23.0	-	-	27.1/26.3/28.2	41.2/55.2/42.7	35.0/46.9/36.5	-	-	-	-	
		2800	8.5/11.4/8.8	12.8/17.2/13.6	16.7/22.4/17.8	20.4/27.4/21.3	29.1/39.0/30.2	-	25.2/33.8/26.1	38.8/51.8/39.9	33.7/45.2/35.0	-	-	-	-	
		2700	8.2/11.0/8.4	12.4/16.8/13.1	16.1/21.6/17.1	19.7/26.4/20.5	-	-	24.3/32.8/25.1	37.1/49.8/38.3	32.5/43.6/33.7	-	-	-	-	
		2600	7.9/10.6/8.1	11.8/15.8/12.5	15.5/20.8/16.5	19.0/25.5/19.7	26.8/35.9/27.7	-	23.5/32.5/24.2	35.7/47.9/36.7	31.3/42.0/32.3	-	-	-	-	
		2500	7.6/10.2/7.8	11.4/15.3/12.0	14.9/20.0/15.8	18.2/24.4/18.9	-	-	22.6/30.3/23.3	34.5/46.3/35.5	30.1/40.4/31.0	43.0/57.7/44.0	51.1/68.5/52.1	62.5/83.8/63.9	67.7/90.8/70.8	-
		2400	7.3/9.8/7.5	11.0/14.8/11.5	14.3/19.2/15.1	17.5/23.5/18.1	-	-	21.6/29.0/22.2	33.5/44.9/34.3	28.8/38.6/29.6	41.6/55.6/42.4	49.3/66.1/50.2	60.3/80.9/61.6	65.5/87.8/68.3	-
		2300	7.0/9.4/7.2	10.5/14.1/11.0	13.8/18.5/14.4	16.8/22.5/17.3	-	-	20.7/27.9/21.2	-	27.7/37.1/28.5	39.9/53.5/40.7	47.4/63.6/48.2	58.0/77.8/59.1	63.4/85.0/65.9	-
		2200	6.6/8.9/6.8	9.9/13.3/10.3	13.2/17.7/13.8	16.0/21.5/16.5	-	-	19.9/26.7/20.4	-	26.5/35.5/27.2	38.3/51.4/39.0	45.6/61.1/46.3	55.5/74.4/56.5	61.4/82.3/63.6	72.0/96.6/74.2
		2100	6.3/8.4/6.5	9.5/12.7/9.9	12.5/16.8/13.0	-	-	-	-	-	-	35.8/47.7/36.2 (-B) 36.8/49.3/37.1	43.8/58.7/44.4	-	59.0/79.1/61.0	70.9/95.1/72.9
2000	6.0/8.0/6.1	9.0/12.1/9.3	11.8/15.8/12.3	-	-	-	18.0/24.1/18.4	-	24.1/32.3/24.6	35.3/47.3/35.9	41.9/56.2/42.5	-	56.6/75.9/58.3	69.9/93.7/71.6		
Generator use	Stand-by	3600	10.0/13.4/10.6	16.0/21.5/17.6	19.5/26.1/21.7	-	-	-	-	-	-	-	-	-	-	
		3000	8.5/11.4/8.6	13.3/17.8/14.3	16.6/22.3/17.9	-	-	-	-	-	-	-	-	-	-	
		1800	-	8.0/10.7/8.3	10.7/14.3/11.1	13.2/17.7/13.8	18.3/24.5/18.6 (-B) 18.8/25.5/19.5	-	16.3/21.9/16.9	26.9/36.1/27.7	21.6/29.0/22.4	-	40.8/54.7/41.6	50.1/67.2/50.9	58.7/78.7/60.5	66.9/89.7/69.4
	1500	-	6.7/9.0/6.8	9.0/12.1/9.2	11.0/14.8/11.3	15.3/20.5/15.5 (-B) 15.8/21.5/16.3	-	13.5/18.1/13.9	21.3/28.6/21.8	18.0/24.1/18.5	-	34.4/46.1/34.9	41.7/55.9/42.2	49.4/66.2/50.5	56.0/75.1/57.6	
	Continuous	3600	9.1/12.2/9.7	14.5/19.4/16.1	17.7/23.7/19.9	-	-	-	-	-	-	-	-	-	-	
		3000	7.7/10.3/8.1	12.1/16.2/13.1	15.1/20.2/16.5	-	-	-	-	-	-	-	-	-	-	
1800		-	7.3/9.8/7.5	9.8/13.1/10.1	12.0/16.1/12.6	16.6/22.5/17.2 (-B) 16.6/22.5/17.3	-	14.8/19.8/15.4	24.3/32.6/25.1	19.6/26.3/20.5	-	36.4/48.8/37.2	45.3/60.7/46.1	53.3/71.5/55.1	60.9/81.7/63.4	
1500	-	6.1/8.2/6.3	8.2/11.0/8.4	9.9/13.3/10.3	14.1/19.1/14.4 (-B) 14.0/19.0/14.4	-	12.3/16.5/12.7	19.1/25.6/19.6	16.4/22.0/16.9	-	30.7/41.2/31.2	37.7/50.6/38.2	41.2/55.3/42.8	50.9/68.3/52.5		



Performance Curves

2TNV70

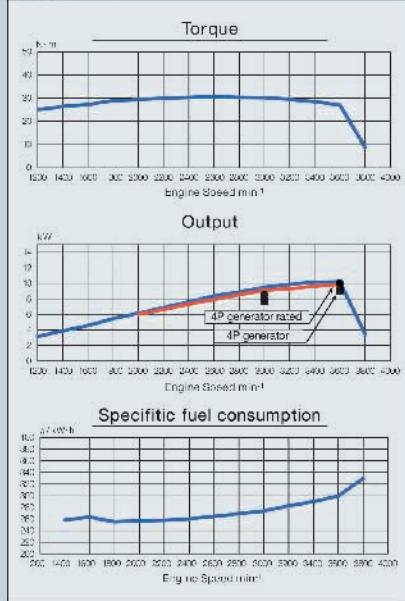

3TNV76

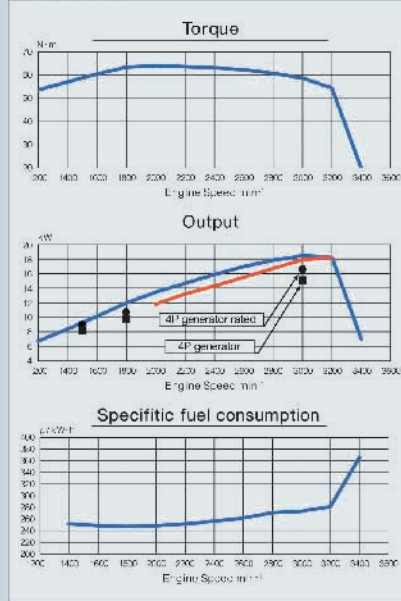

3TNV70

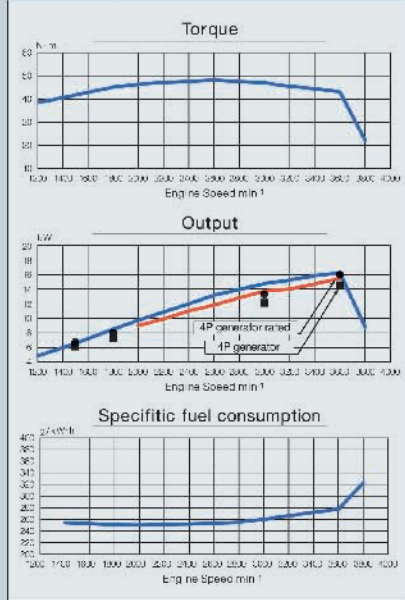

3TNV82A(-B)

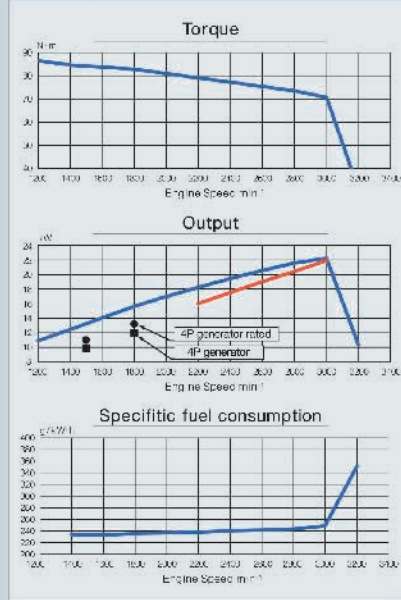

3TNV84T(-B)

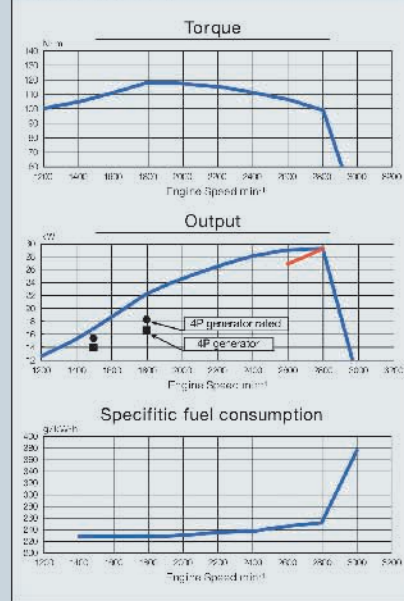

3TNV88(-B)

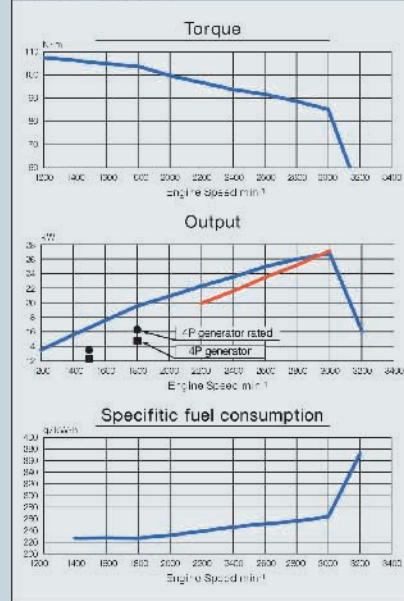

4TNV84T(-B)

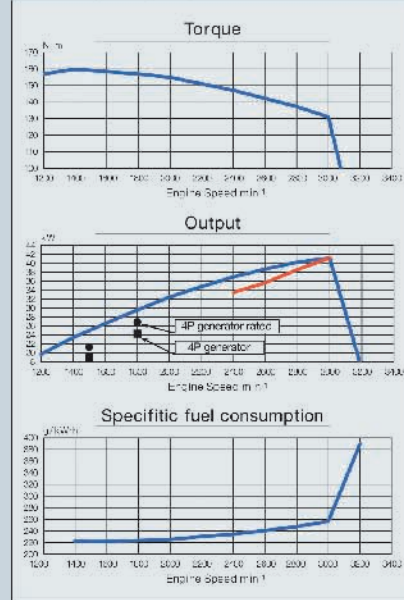

4TNV88(-B)

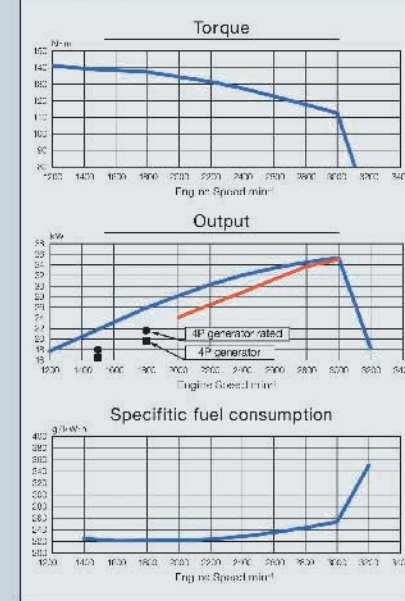

4TNV94L(-B)

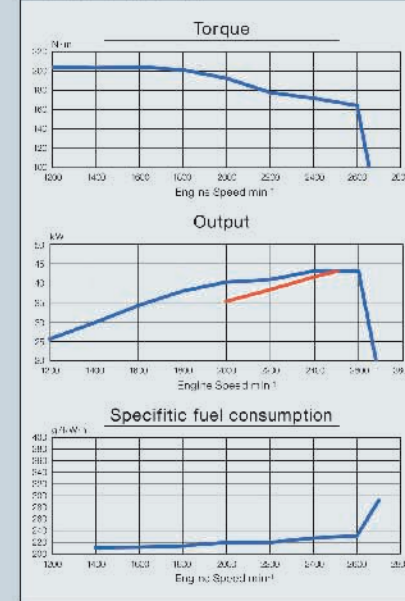

4TNV98

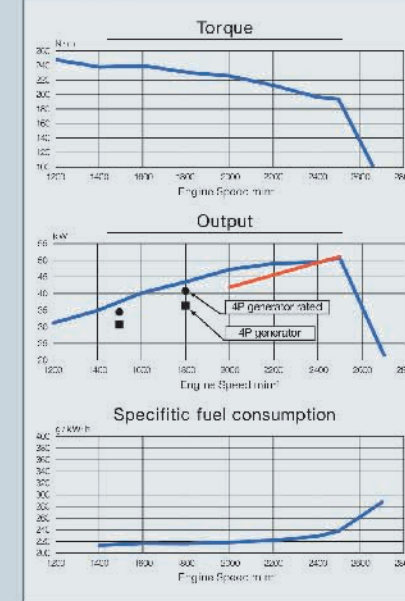

4TNV98T

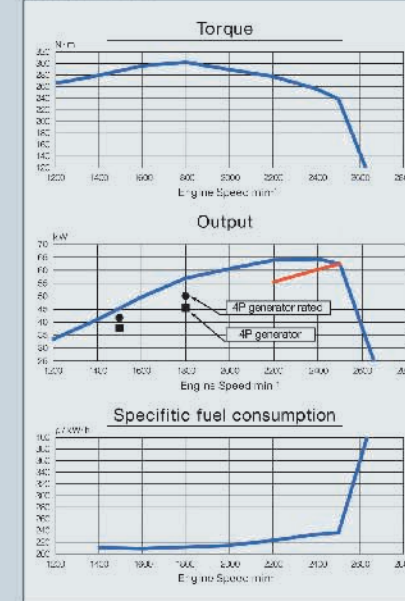

4TNV106

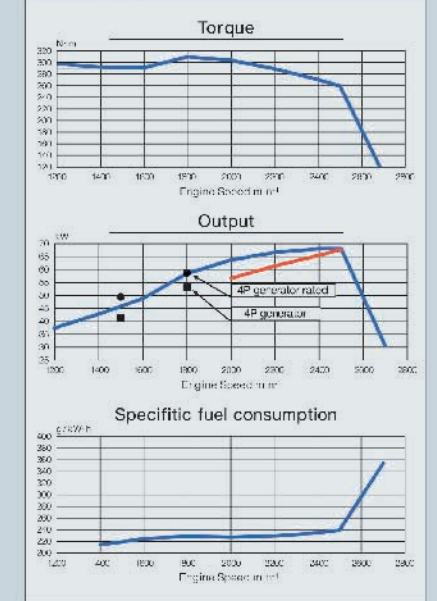

4TNV106T

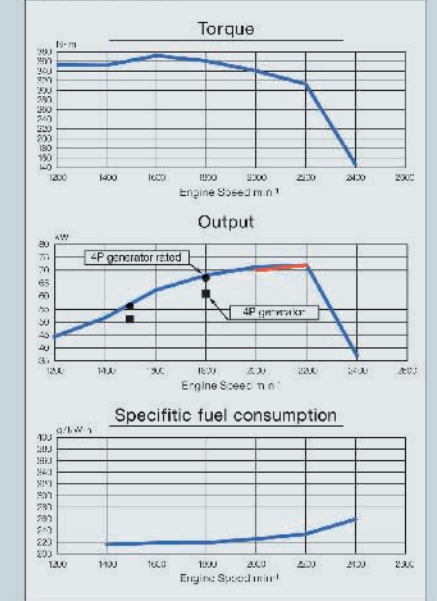

Engine Dimensions

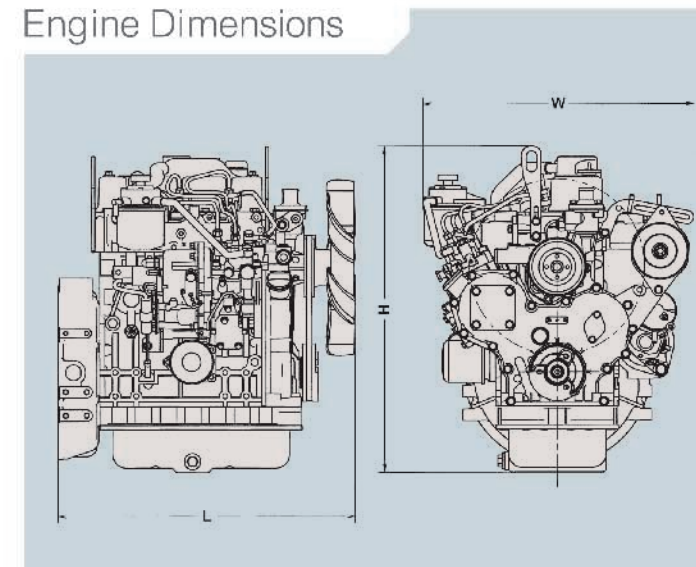

Unit: mm

Model	2TNV70	3TNV70	3TNV76
L	415	504	524
W	427	427	427
H	521	549	572

Model	3TNV82A	3TNV84T	3TNV88	4TNV84T	4TNV88
L	528.5	615.7	564.5	655	655
W	498.5	517.5	517.5	517.5	517.5
H	561	652	622	685	622

Model	4TNV94L	4TNV98	4TNV98T
L	719	719	719
W	496	496	574
H	717	717	784

Model	4TNV106	4TNV106T
L	890	890
W	628	628
H	820	869